

## Description

The PESD2CAN is a bi-directional TVS diode array, utilizing leading monolithic silicon technology to provide fast response time and low ESD clamping voltage, making this device an ideal solution for protecting sensitive semiconductor components from damage. The PESD2CAN complies with the IEC 61000-4-2 (ESD) standard with  $\pm 15\text{kV}$  air and  $\pm 8\text{kV}$  contact discharge. It is assembled into a lead-free SOT-23 package. It is designed to protect components which are connected to data and transmission lines from voltage surges.

## Circuit Diagram

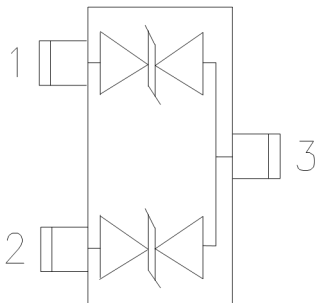

## Marking Diagram

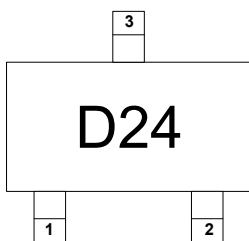

### Transparent top view

D24: Device Marking Code

## Features

- \* 420W peak pulse power (8/20 $\mu\text{s}$ )
- \* Protects two bi-directional lines
- \* Ultra low leakage: nA level
- \* Operating voltage: 24V
- \* AEC-Q101 qualified
- \* Low clamping voltage
- \* Complies with following standards:
  - IEC 61000-4-2 (ESD) immunity test
    - Air discharge:  $\pm 30\text{kV}$
    - Contact discharge:  $\pm 30\text{kV}$
  - IEC61000-4-4 (EFT) 40A (5/50ns)
  - IEC61000-4-5 (Lightning) 9A (8/20 $\mu\text{s}$ )
- \* RoHS Compliant

## Applications

- \* Cellular Handsets and Accessories
- \* Notebooks and Handhelds
- \* Portable Instrumentation
- \* Set Top Box
- \* Industrial Controls
- \* Server and Desktop PC

## Ordering Information

Part Number	Packaging	Reel Size
PESD2CAN	3000/Tape & Reel	7 inch

### Absolute Maximum Ratings ( $T_A=25^{\circ}\text{C}$ unless otherwise specified)

Parameter	Symbol	Value	Unit
Peak Pulse Power (8/20 $\mu\text{s}$ )	Ppk	420	W
Peak Pulse Current (8/20 $\mu\text{s}$ )	IPP	9	A
ESD per IEC 61000-4-2 (Air)	VESD	$\pm 30$	kV
ESD per IEC 61000-4-2 (Contact)		$\pm 30$	
Operating Temperature Range	TJ	-55 to +125	$^{\circ}\text{C}$
Storage Temperature Range	Tstg	-55 to +150	$^{\circ}\text{C}$

### Electrical Characteristics ( $T_A=25^{\circ}\text{C}$ unless otherwise specified)

Parameter	Symbol	Test Condition	Min	Typ	Max	Unit
Reverse Working Voltage	$V_{RWM}$				24	V
Breakdown Voltage	$V_{BR}$	$I_T = 1\text{mA}$	26	28.5	30.5	V
Reverse Leakage Current	$I_R$	$V_{RWM} = 24\text{V}$			0.5	$\mu\text{A}$
Clamping Voltage	$V_C$	$I_{PP} = 1\text{A}$ (8 x 20 $\mu\text{s}$ pulse)		35	40	V
Clamping Voltage	$V_C$	$I_{PP} = 9\text{A}$ (8 x 20 $\mu\text{s}$ pulse)		45	58	V
Junction Capacitance	$C_J$	$V_R = 0\text{V}$ , $f = 1\text{MHz}$		30	50	pF

### Portion Electronics Parameter

Symbol	Parameter
$I_T$	Test Current
$I_{PP}$	Maximum Reverse Peak Pulse Current
$V_C$	Clamping Voltage @ $I_C$

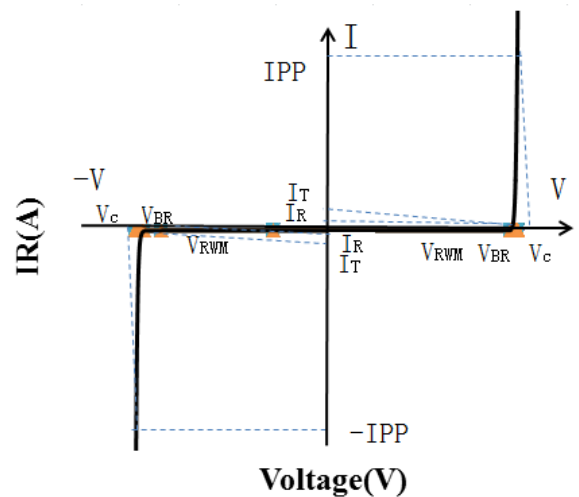



### Typical Performance Characteristics ( $T_A=25^{\circ}\text{C}$ unless otherwise Specified)

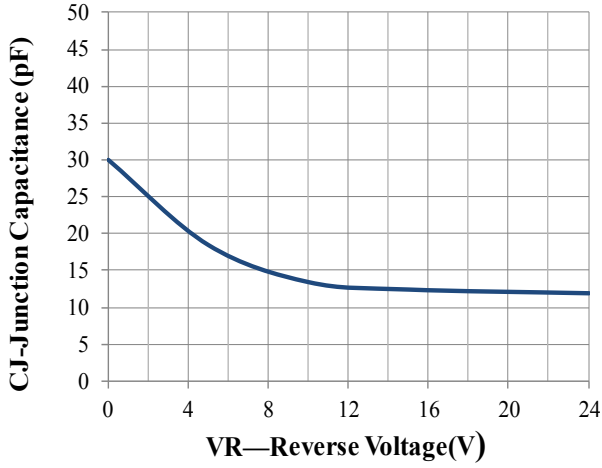

Junction Capacitance vs. Reverse Voltage

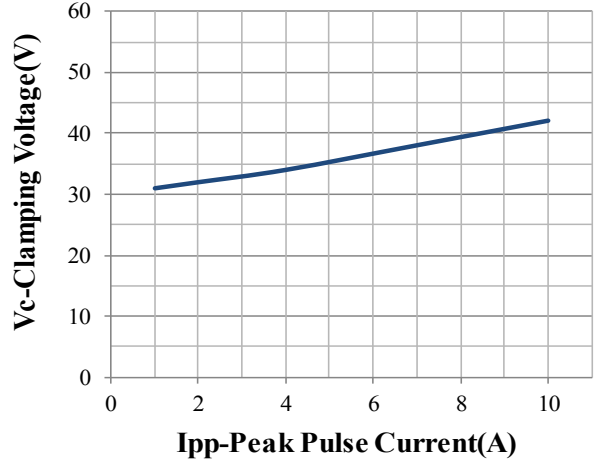

Clamping Voltage vs. Peak Pulse Current

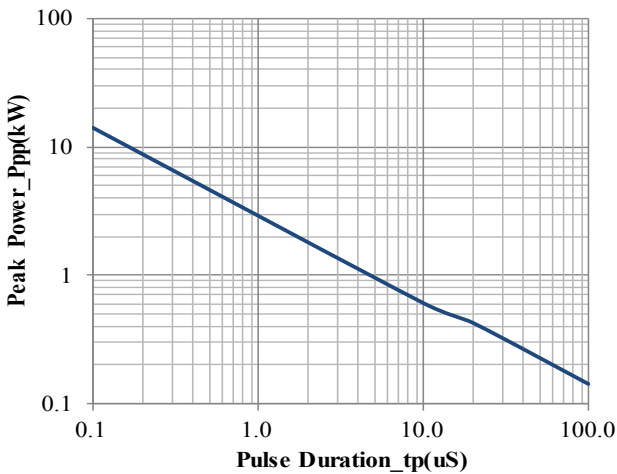

Peak Pulse Power vs. Pulse Time

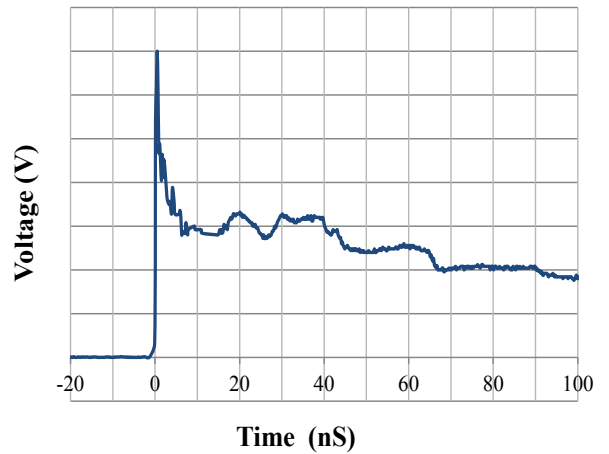

IEC61000-4-2 Pulse Waveform

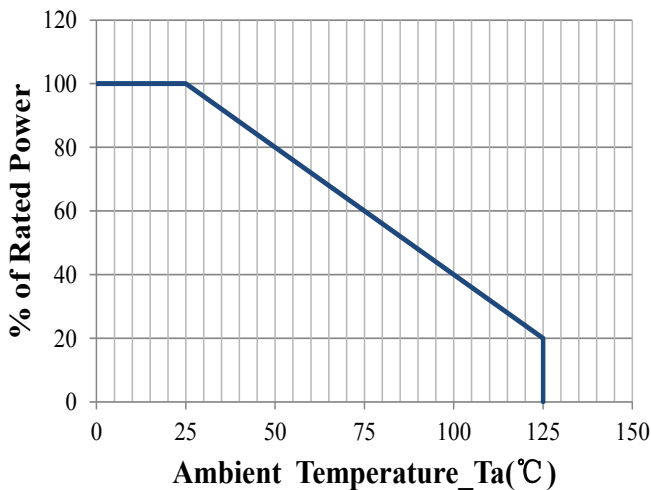

Power Derating Curve

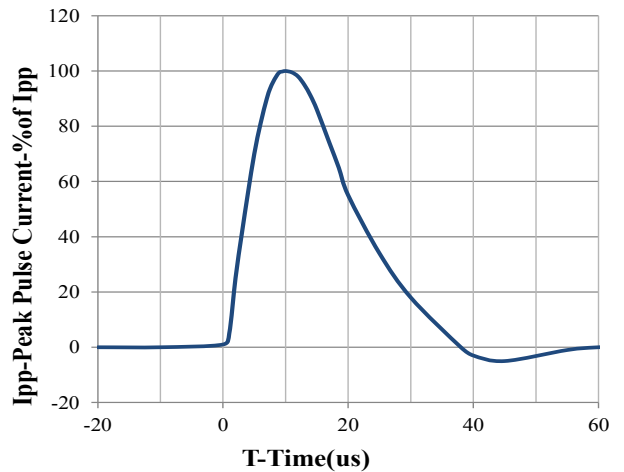

8 X 20us Pulse Waveform

## SOT-23 Package Outline Drawing

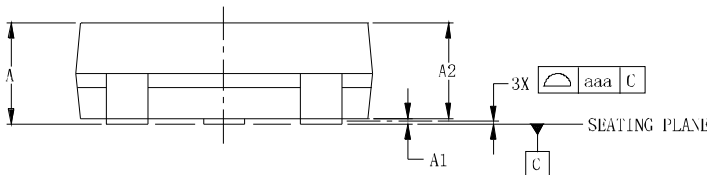
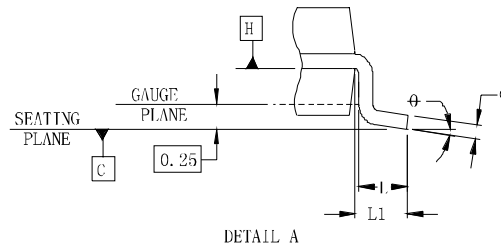
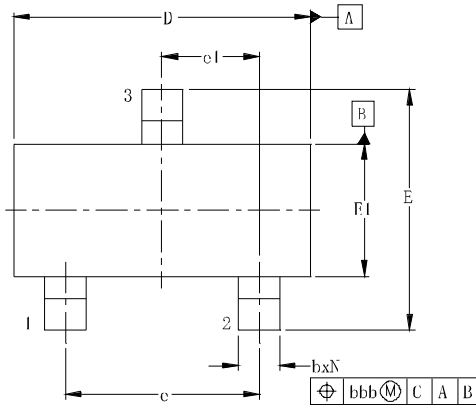

DIM	DIMENSIONS					
	INCHES			MILLIMETERS		
	MTN	NOM	MAX	MTN	NOM	MAX
A	.035	—	.044	0.89	—	1.12
A1	.000	—	.004	0.01	—	0.10
A2	.035	.037	.040	0.88	0.95	1.02
b	.012	—	.020	0.30	—	0.51
c	.003	—	.007	0.08	—	0.18
D	.110	.114	.120	2.80	2.90	3.04
E	.082	.093	.104	2.10	2.37	2.64
E1	.047	.051	.055	1.20	1.30	1.40
e	.075		1.90 BSC			
e1	.037		0.95 BSC			
L	.015	.020	.024	0.40	0.50	0.60
L1	.022		(0.55)			
N	3		3			
$\theta$	0°	—	8°	0°	—	8°
aaa	.001		0.10			
bbb	.008		0.20			

## Suggested Land Pattern

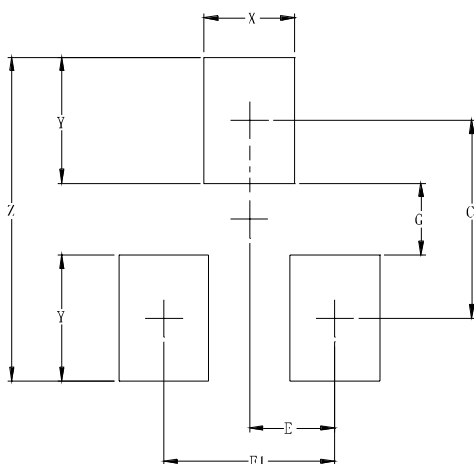

DIM	DIMENSIONS	
	INCHES	MILLIMETERS
C	.087	2.20
E	.037	0.95
E1	.075	1.90
G	.031	0.80
X	.039	1.00
Y	.055	1.40
Z	.141	3.60